



PIEDS GX2.0
RABATTABLES, ENCASTRABLES

NEW



DESIGN & PERFORMANCE

La nouvelle génération de pieds GX2 a été conçue pour résister aux environnements extérieurs les plus agressifs : fronts de mer ou zones enneigées, des atouts décisifs pour le mobilier professionnel outdoor.

+ PRODUIT

- Design & couleurs :
4 couleurs tendance pour tous les styles de terrasses
- Gamme complète : pieds standard, haut et double
- Haute résistance à la corrosion :
usage front de mer - conception multi-matériaux
- Pied rabattable & encastrable :
système Grosfillex éprouvé
- Fabrication Française : disponibilité & garantie



Grosfillex system
Blocage de sécurité en ouverture & fermeture



Pied encastrable

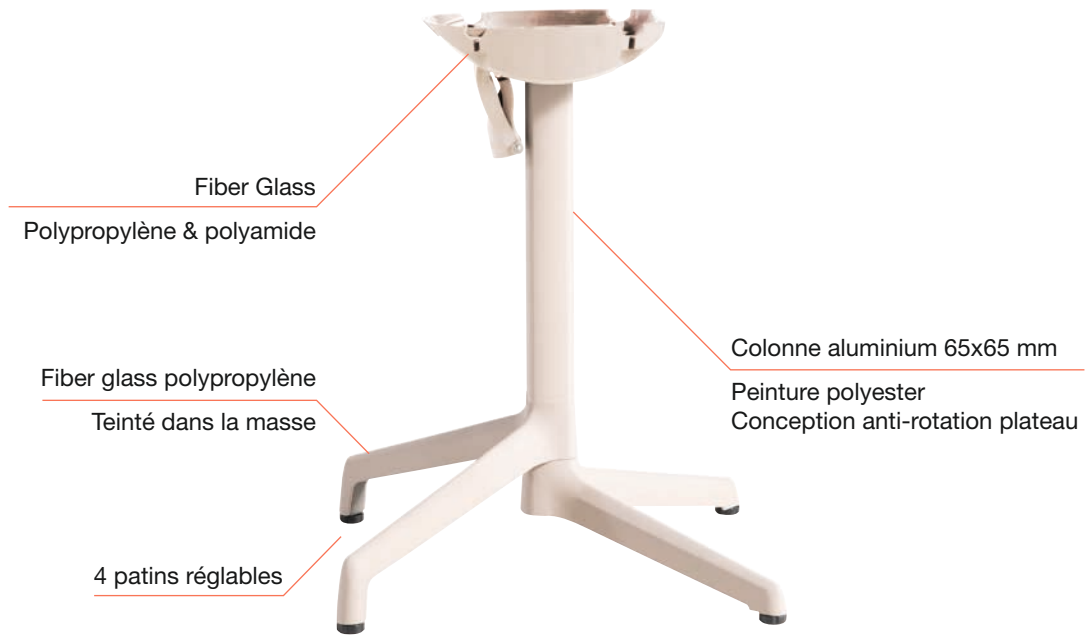

Visserie pied & plateau fournie

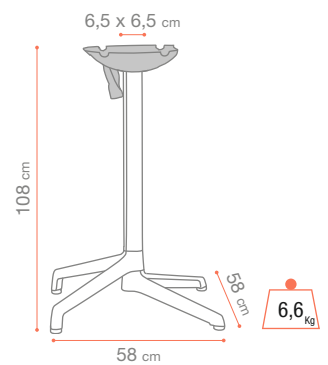
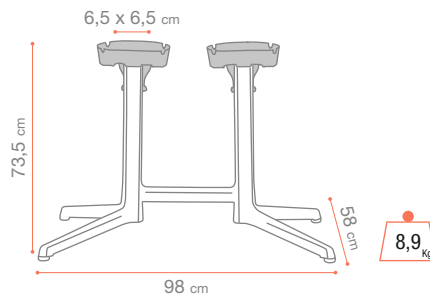
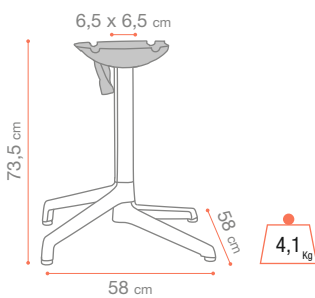

	ø70	60x70	70x70	80x80	110x70	120x80
X2.0	•	•	•	•		
X2.0 HAUT	•	•	•	•		
X2.0 DOUBLE					•	•

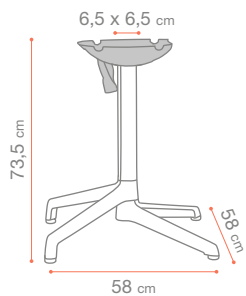

Anthracite
U3 901 002



Gris Platinum
U3 901 289



Havane
U3 901 011



Terracotta
U3 901 814

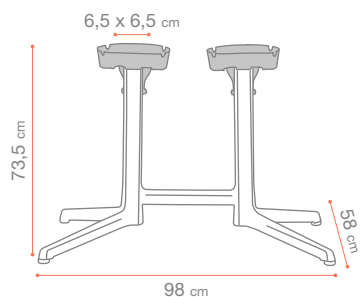

Anthracite
U4 101 002



Gris Platinum
U4 101 289



Havane
U4 101 011



Terracotta
U4 101 814

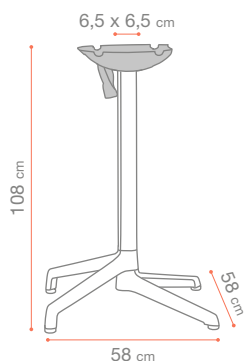

Anthracite
U4 001 002



Gris Platinum
U4 001 289



Havane
U4 001 011

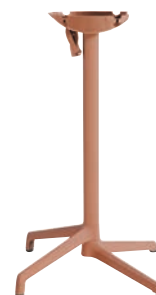

Terracotta
U4 001 814



* Conforme aux normes européennes EN 581-1/3 : produit testé en sécurité, résistance et stabilité pour un usage collectif.

PIÈCES S.A.V.

Désignation	Référence
TUBE PIED X2 STD ANTHRACITE	ZCK2002
TUBE PIED X2 STD HAVANE	ZCK2011
TUBE PIED X2 STD GRIS PLAT	ZCK2289
TUBE PIED X2 STD TERRACOTTA	ZCK2814
TUBE PIED X2 HT ANTHRACITE	ZCK3002
TUBE PIED X2 HT HAVANE	ZCK3011
TUBE PIED X2 HT GRIS PLAT	ZCK3289
TUBE PIED X2 HT TERRACOTTA	ZCK3814
JEU 4 PATINS M8	ZCO8